



Quick Start Setup Instructions for Raven RCM & AgXcel Harness for 1 Liquid Product

PLEASE NOTE: Your setup may vary. These screen shots represents a typical AgXcel Liquid Fertilizer System setup. See the Raven LRC Operator's Manual for safety information and additional setup and operating information.

1. Navigate to the Applicator Setup Screen



For the initial setup, start a new profile. The Raven LRC allows you to store 8 profiles.

2. Name Profile

Press Change/New & enter Profile Name, Machine Type, Application Width

For single product applications, your Machine Type needs to be Liquid Fert. Tool

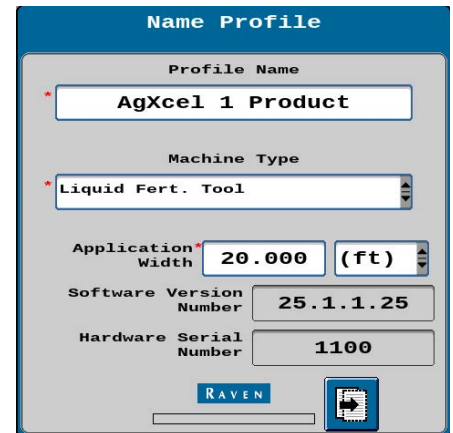
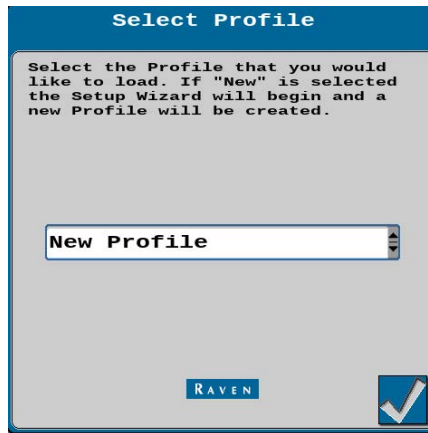
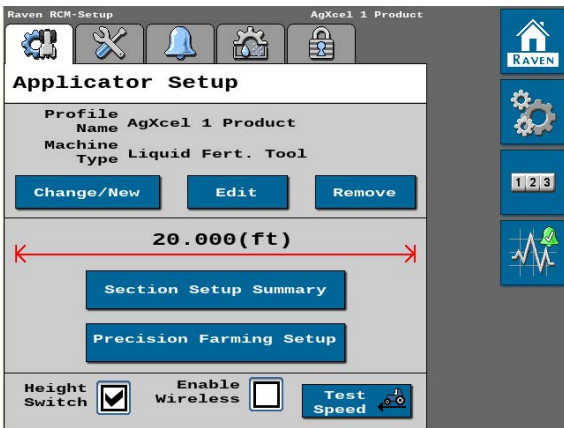

3. Enter the number of ECU's you will be using and number of products

4. Select LIQUID for Product 1

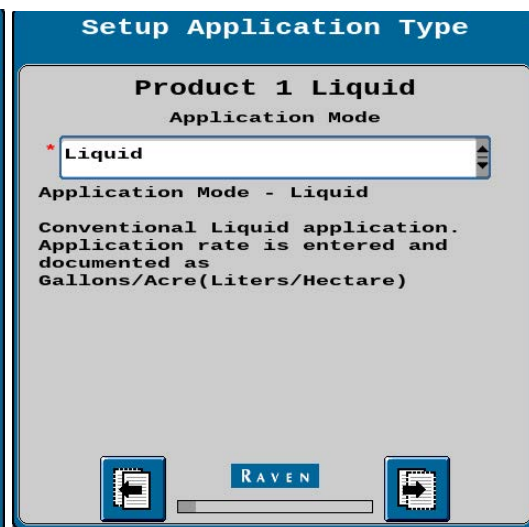
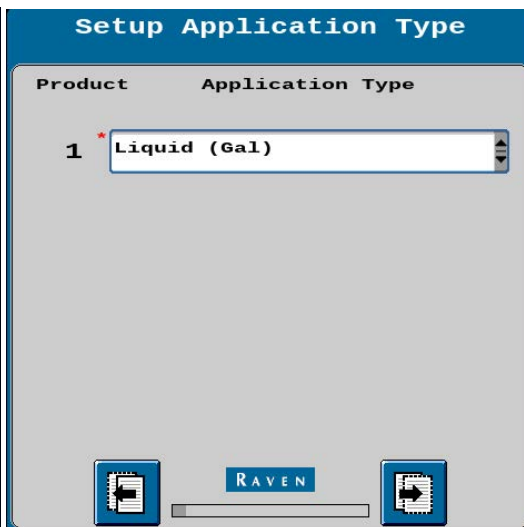
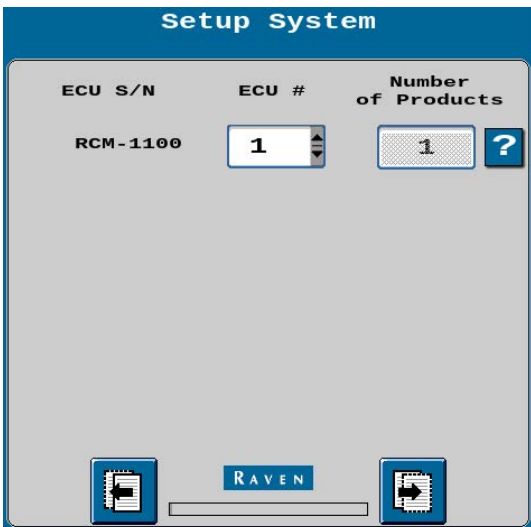

Quick Start Setup Instructions for Raven RCM & AgXcel Harness for 1 Liquid Product

5. Setup Section Groups

Enter how many sections you have and ensure the "Master Clutch" in unchecked.

Also enter the correct width for each section

Setup Sections

Number of Sections: ?

Section Valve Type:

Equal Width Sections:

RAVEN

Setup Section Width

Enter the width of the sections

1* (ft)

2 (ft)

3 (ft)

RAVEN

6. The AgXcel Pressure Sensor will be setup as a Custom sensor if you purchased an AgXcel Pressure Sensor. Calibration will be done later.

Setup Pressure Sensors

Product 1 Liquid ?

Pressure Sensor 1:

Pressure Sensor 2:

Verify Pressure Calibration after Setup Wizard. For "Custom" sensor types refer to Advanced Pressure Calibration.

RAVEN

Setup Pressure Alarms

	Min	Max	Alarm?
Pressure 1 (PSI)	<input type="text" value="0"/>	<input type="text" value="100"/>	<input type="checkbox"/> ?
Pressure 2 (PSI)	<input type="text" value="0"/>	<input type="text" value="0"/>	<input type="checkbox"/>

RAVEN

The max pressure is 100 PSI for AgXcel transducers

7. If you are using an AgXcel provided height switch, you will want to select Digital NPN

Setup Auxiliary Functions

Agitator Installed: ?

Flow Return Installed:

Height Switch:

RAVEN

Quick Start Setup Instructions for Raven RCM & AgXcel Harness for 1 Liquid Product



AgXcel does not recommend Enabling PWM Smart Control

8. Control Valve Setup (use the number indicated for your system)

Valve Response Rate: *(Adjust as needed)*

GX5 (hydraulic diaphragm)....100

GX5 (hydraulic centrifugal)....15

GX2 (electric).....100

GX12HP.....80

If the pump is slow to respond to rate changes or speed changes, increase the Valve Response Rate 10hz at a time. If the product surges around the rate, then reduce the Valve Response Rate.

9. Control Deadband: 2

10. Coil Frequency:

GX5 (hydraulic diaphragm)....100

GX5 (hydraulic centrifugal)....122

GX2 (electric).....100

11. PWM High Limit:

GX5 (hydraulic diaphragm)....100

GX5 (hydraulic centrifugal)....100

GX2 (electric).....100

12. Low Limit *(Adjust in field as needed)*

GX5 (hydraulic diaphragm)....20

GX5 (hydraulic centrifugal)....15

GX2 (electric).....0

13. PWM Startup *(Adjust in field as needed)*

GX5 (hydraulic diaphragm)....15

GX5 (hydraulic centrifugal)....15

GX2 (electric).....10

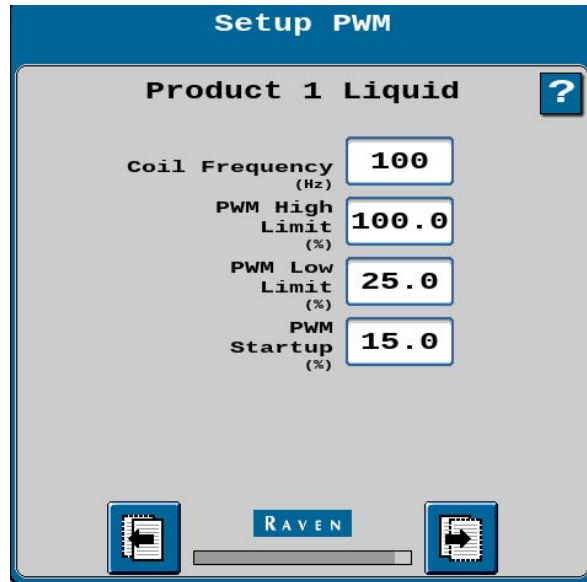

For best startup performance, set the PWM Startup at or slightly above the normal operating PWM Duty Cycle (DC%). When the pump starts it will go immediately to that Duty Cycle and then will have just a minor adjustment to lock on to the Target Rate. **IF THE PUMP STARTS TOO FAST, LOWER THE PWM STARTUP.**

Average Operation:

37.1 DC%

Quick Start Setup Instructions for Raven RCM & AgXcel Harness for 1 Liquid Product

14. Enter appropriate Flowmeter Cal number

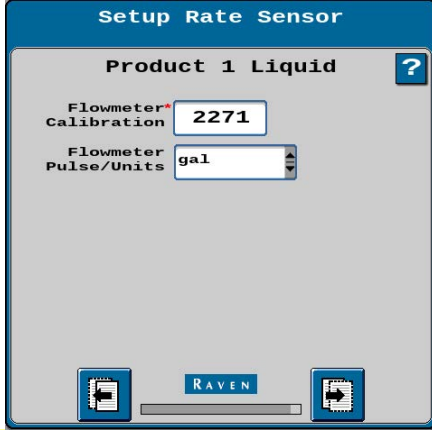

CAUTION: When choosing pulses/gal, be sure to choose the “gal” unit, NOT the “1 gal” unit.

Orion 2 Magnetic Flowmeters

0.08 - 1.6 GPM	22710
0.13 - 2.6 GPM	22710
0.3 - 5 GPM	11355
0.6 - 13 GPM	4542
1.3 - 26 GPM	2271
2.6 - 53 GPM	1135

Orion 3 Magnetic Flowmeters

0.04 - 1.6 GPM (DN3)	75712
0.08 - 3.17 GPM (DN4)	37854
0.26 - 10.5 GPM (DN7)	11356
0.52 - 21 GPM (DN10)	4245
1.45 - 58 GPM (DN17)	2063

Check the yellow sticker on your manual packet for your flow calibration number or the side of the flowmeter

15. Tank & Fill Setup

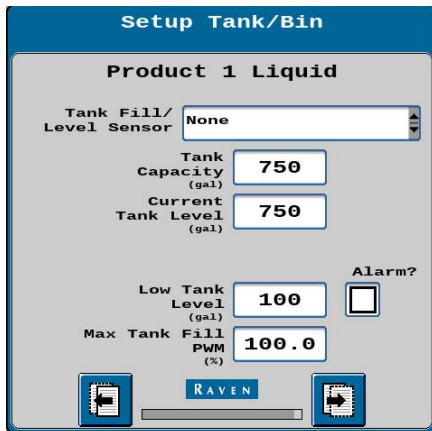

Enter your tank information and when you want a notification when your tank level is low

16. Set Rates & Rate Smoothing

Rate bump will be the value at which the target GPA rate is adjusted when manually changing rates in the field.

Check the Decimal Shift box to enter rates with one more decimal point (such as 0.25 GPA).

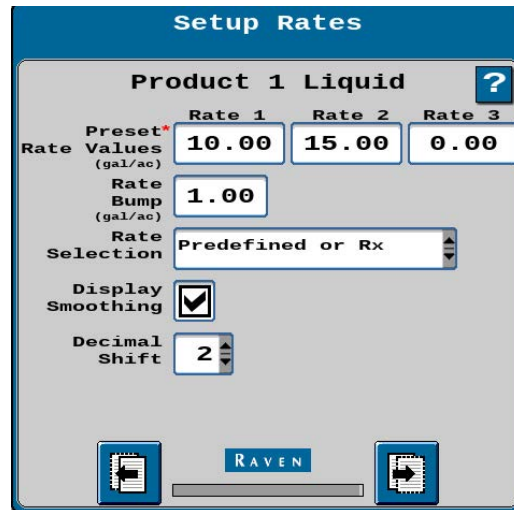

17. Set Off Rate Alarm as desired

Set the desired off rate percentage at which the liquid controller will alarm you if you are off of your target rate. 20% is default and recommended.

The Minimum Flow Rate box will not be present if a pressure sensor has been assigned to this product. **Keep Minimum Flow Rate at 0.**

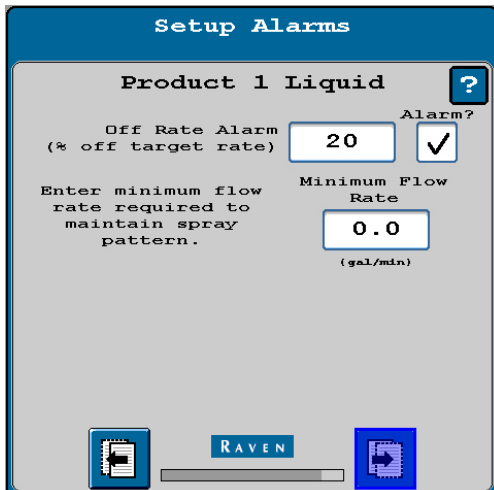

Quick Start Setup Instructions for Raven RCM & AgXcel Harness for 1 Liquid Product

18. Pressure Sensor

When using an AgXcel pressure sensor, the steps must be performed below. AgXcel uses a 0 - 100 PSI pressure transducer and a calibration number of **50.0 mv/PSI** is to be used. To ensure that the sensor is properly calibrated, please make sure that the M12 connector with a **GREEN lit LED** is **DISCONNECTED** from the sensor, this will ensure that the sensor does not detect any pressure in the system. 0 Pressure = 0.00 V.

For complete information on how the **Sensor** is operating, go to:
Diagnostics > Readings > Pressure Sensors. 0 Pressure Voltage should be 0.00 V .

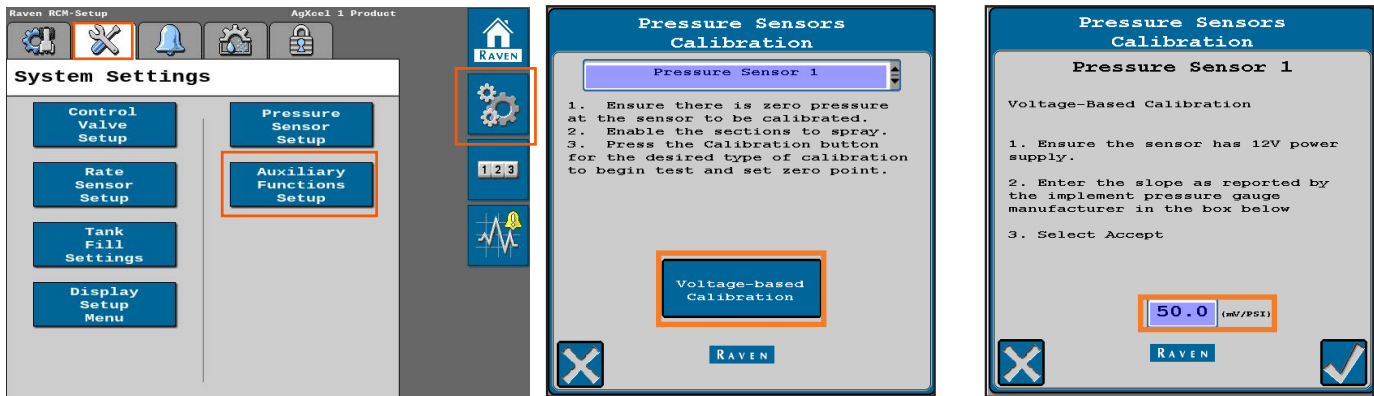

19. Advance Tuning

Many times the Control Valve Settings need to be adjusted further to ensure proper function. Therefore, additional fine tuning using the Raven LRC under the Advance Tuning section is required. For the AgXcel GX2 or GX5 systems, the PIDS values must be modified. For more in-depth details of this feature press the ? button.

Only change these settings if you notice that your pump system is always surging above and below your target rate.

Default Settings are:

P = 50 D = 50
I = 20 S = 50

PID Valve Tuning for AgXcel GX2 & GX5 Electric System:

Set P = 1 D = 5
Set I = 50 S = 1

Setting P = 100 and S = 100 will ensure the quickest response from the AgXcel GX2 Electric System

Press and HOLD the SETTINGS tab for about 10 seconds until the Advanced Tuning button displays

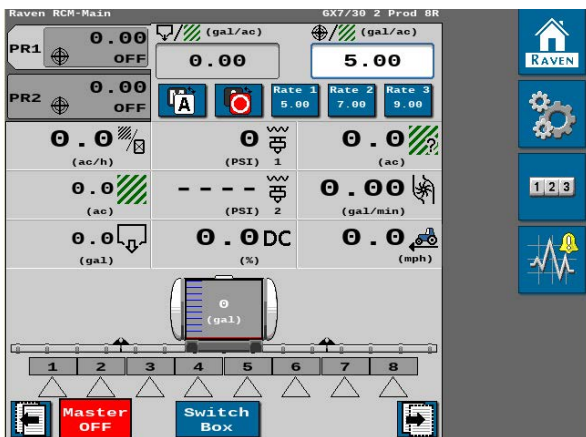
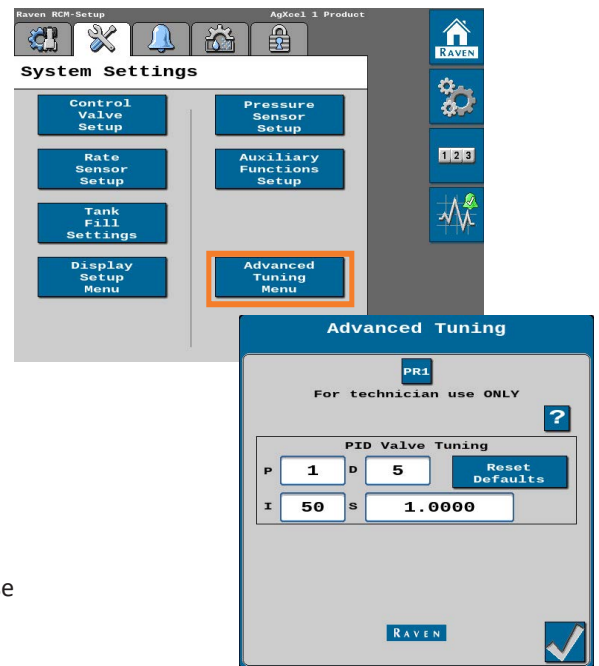

Ensure that you have these options selected:

Volume Per Minute

Speed Layout

Task Area

Pressure Readout (if you have a Pressure Transducer)

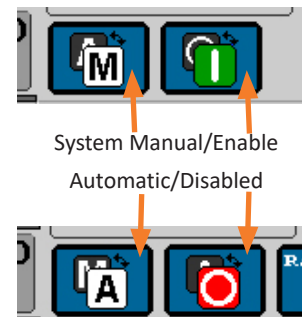



Quick Start Setup Instructions for Raven RCM & AgXcel Harness for 1 Liquid Product

AgXcel Liquid System Frequency Asked Questions (FAQ)

I am trying to achieve 5 GPA but my system will not go lower than 9 GPA.

- Make sure your PWM Low Limit is set to a number that is lower than your required lowest rate. This can be found in your Valve Control PWM settings on your console. If the PWM Low Limit is set too high you will not be able to achieve the lowest rate possible if set other than 10. Many times setting the Low Limit to 0 will work just fine especially when running lower rates.
- With an AgXcel System always make sure your Minimum Flow rate is set to 0.0 GPM or your system will not drop below this rate. For example if the Minimum flow rate is set to 3 GPM your system will not drop below this setting so if your required GPA requires 2.1 GPM then your system will not achieve this rate given that you have set the Minimum Flow rate to 3 GPM.
- When using an AgXcel GX5 Hydraulic system, make sure the AgXcel silver hyd valve is NOT in manual override. Check to ensure that the RED knob on top of the valve is pressed down by turning the knob clockwise while pressing the RED knob down. This will lock the PWM valve down so that the electronic solenoid can control the hyd flow.

I am trying to achieve 12 GPA but my system will only go up to 8 GPA on my GX5 Hyd system or I am trying to achieve 8GPA and can only achieve 5 GPA on my GX2 electric system.

AgXcel GX2 Electric System

- What is your system pressure? If system pressure is too high (50PSI or above) this will prevent you from achieving your highest rate possible. High system pressure with an electric system can put the electric pump head into bypass mode and will not allow for full flow.
- Check the following areas to lower your pressure
 1. Select a larger orifice or Micro Tube with a larger hole, this will allow for easier flow of liquid through the system and can increase overall flow and GPA
 2. Check your system filters and make sure they are clean. This should be a practice each morning before using the system
- AgXcel GX2 Electric Systems can achieve up to about 5.9 GPM with dual electric pumps. Check your total GPM requirements and ensure that you are within range
- When using a Dual Pump System – unplug 1 pump and ensure that the other pump is working. Perform this test with both pumps and if one pump sounds weak replace it immediately



Quick Start Setup Instructions for Raven RCM & AgXcel Harness for 1 Liquid Product

Continued.....

- Ensure that your PWM High Limit is set to 100. Many times an Auto Tune will set this to a lower number so make sure this is set to 100
- If your controller has this option, make sure the PWM Duty Cycle is within range
- Check all your boom widths and make sure that all are set correctly

AgXcel GX5 Hyd System

- What is your system pressure? If system pressure is too high (90PSI or above) this will prevent you from achieving your high-est rate possible. High system pressure with a hydraulic system set 100 PSI bypass spike valve to open and you could begin to lose volume
- Check the following areas to lower your pressure
 1. Select a larger orifice or Micro Tube with a larger hole, this will allow for easier flow of liquid through the system and can increase over all flow and GPA
 2. Check your system filters and make sure they are clean. This should be a practice each morning before using the system
- Check your total GPM requirements and ensure that you are within range of the GX5 hyd pumps recommended GPM
- Ensure that your PWM High Limit is set to 100. Many times an Auto Tune will set this to a lower number so make sure this is set to 100
- If your controller has this option, make sure the PWM Duty Cycle is within range
- Check all your boom widths and make sure that all are set correctly

My rate is fluctuating and is almost locking in but just around.

- Make sure that your Rate Smoothing is checked and set to 10. You can typically find this setting under your System Controller settings. Rate Smoothing allows the system to lock into the rate if the rate is within 10% of the required rate. Many times liquid temperature can affect the performance of the system ‘
- Make sure your pressure is enough to fully OPEN every check valve on the implement. A good rule of thumb is to ensure that pressure is higher than 15 PSI when using 4lb, 5lb and especially 10lb check valves



Quick Start Setup Instructions for Raven RCM & AgXcel Harness for 1 Liquid Product

How do I know where my pressure should be?

- AgXcel systems are not pressure based especially when they are controlled with a Liquid Rate Control Module. HOWEVER, pressure can affect the performance of the system if the pressure is too low or too high. Many users feel that the higher the pressure then the less chance they have to plug an orifice. Although this statement holds value it can also have a major effect on system performance

- **Low pressure – RECOMMENDED 15PSI is the lowest**

1. Can affect the performance of the pump and may cause it to surge which affect the accuracy of your flow
2. Can affect the performance of your system check valves, not enough pressure and all your check valves may not OPEN and this may affect the accuracy of your system

- **High Pressure – RECOMMENDED – GX2 Electric = 25PSI GX5 Hyd = 70PSI**

1. Too high of pressure can also affect the performance of your system as this can cause too much restriction in the mani- fold tubes and too much resistance will slow the rate down

- **RULE OF THUMB FOR PRESSURE**

- AgXcel GX2 systems = 10PSI – 20 PSI
- AgXcel GX5 Hyd systems
 - Low Range = 15PSI – 40 PSI
 - Medium Range = 20PSI – 50PSI
 - High Range = 40PSI – 80PSI
- All these ranges are OK for the AgXcel GX5 system
- For High Speed Planters check out the AgXcel GX30 VRT Solution

How do I raise and lower my pressure when required?

- If your pressure is too HIGH then increase the size of your orifice and or Micro Tube to a larger hole size
- If your pressure is too LOW then change the size of your orifice or Micro Tube to a smaller hole size

AgXcel Raven RCM 2 Product Harness

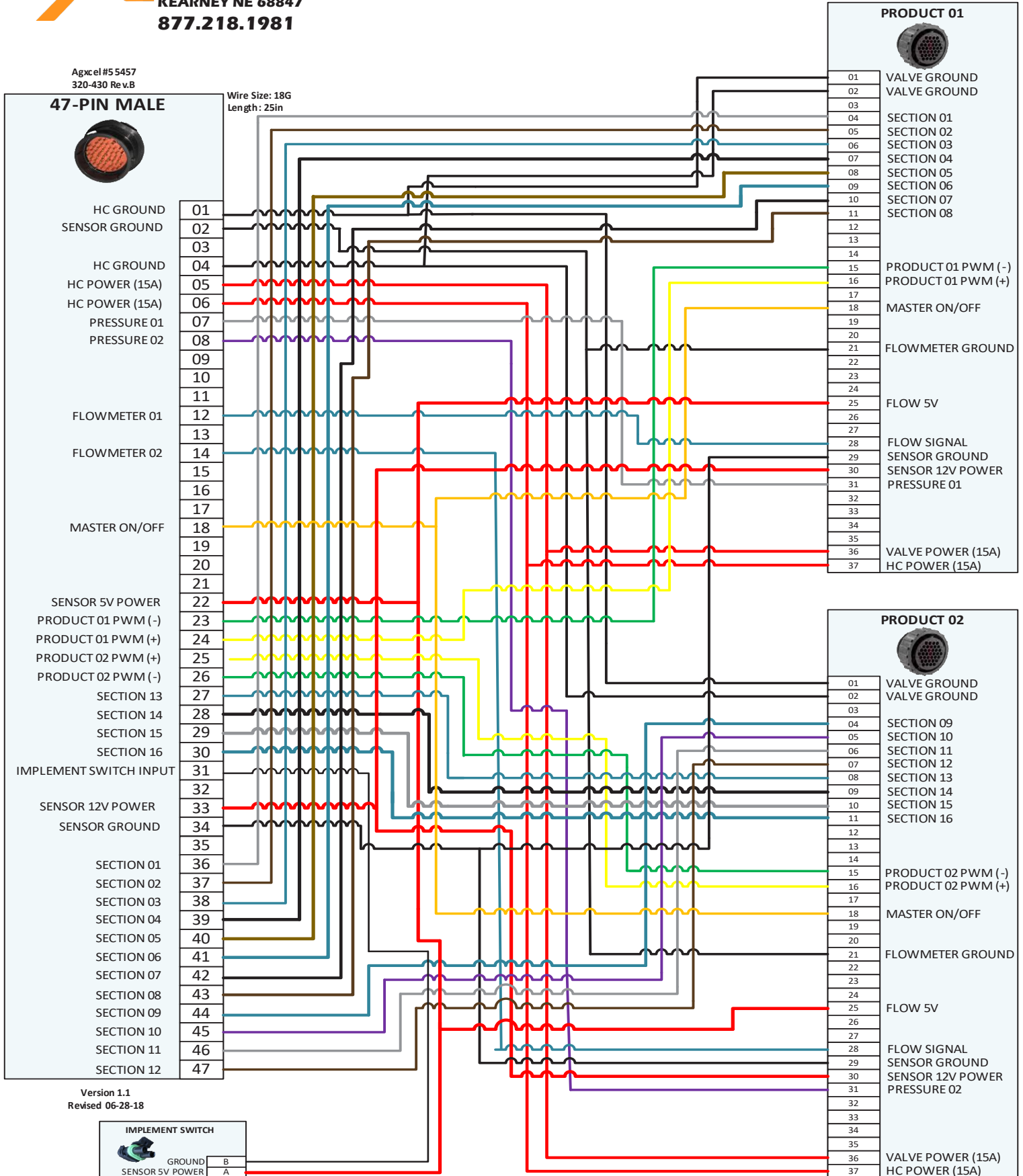

AgXcel Raven Integration Harness 37-Round Pin to Twin 16-Round Pin "Y" Connector

Agxcel #53593
309-524

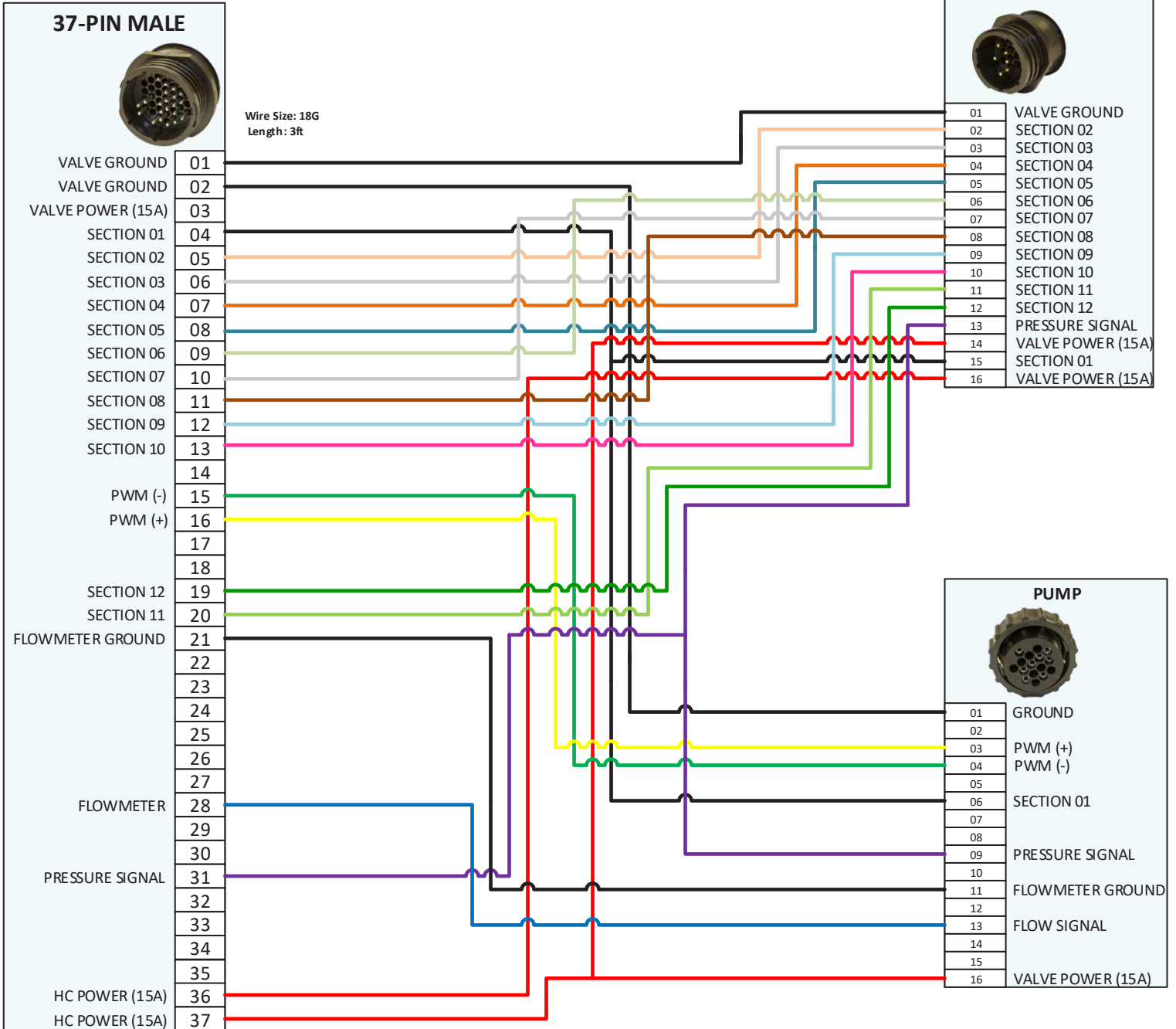

AgXcel Channel Integration Harness (PWM, Flowmeter, Pressure)

Agxcel #53697
 309-506

16-PIN ROUND
 CONNECTOR TO NH3



Wire Size: 18G
 Length: 10ft

GND	01
	02
Servo (+) PWM	03
Servo (-) PWM	04
Flow 5V	05
12V Sensor Power	06
Sensor GND	07
	08
Pressure Signal 1	09
Pressure Signal 2	10
Flow GND	11
	12
Flow Signal	13
	14
MASTER ON/OFF	15
Power	16

PRESSURE 01



PURP	A	Pressure Signal 1
RED02C	B	Power
BLK03C	C	Flow GND

12V FLOW

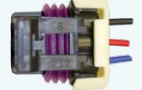

BLU01A	A	Flow Signal
RED02B	B	12V Sensor Power
BLK03B	C	Flow GND

PRESSURE 02



PURP/WHT	A	Pressure Signal 2
RED02D	B	Power
BLK03D	C	Flow GND

PWM

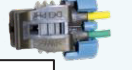

YEL	A	PWM (+)
GRN	B	PWM (-)

Version 1.0
 Created 07-2-18

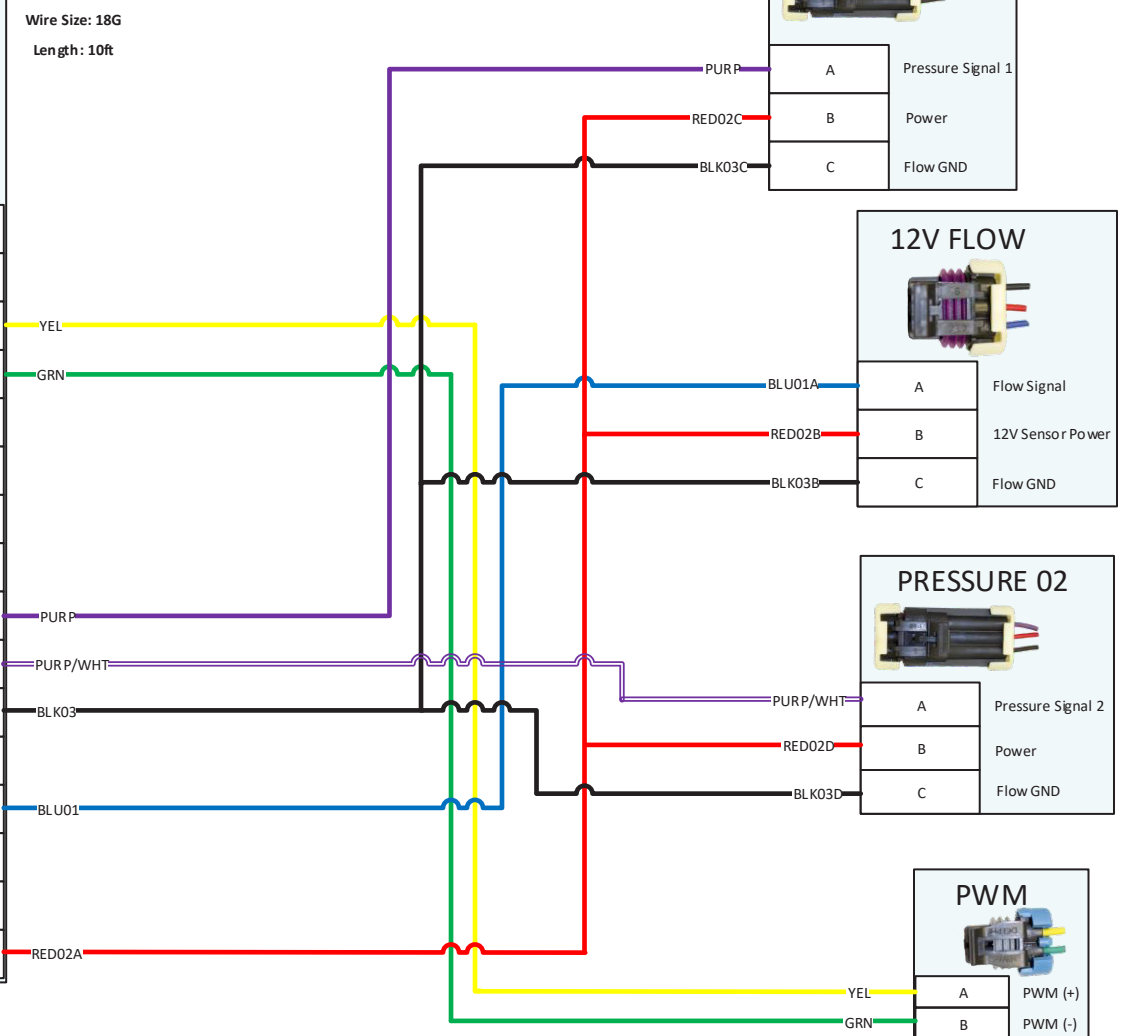

**AgXcel Section
 Harness**

