

# MANUAL RATE CONTROL KIT

**SINGLE PUMP PN# 563**

**DUAL PUMP PN# 564**



**116 E 6TH ST  
KEARNEY NE 68847**

**877.218.1981**

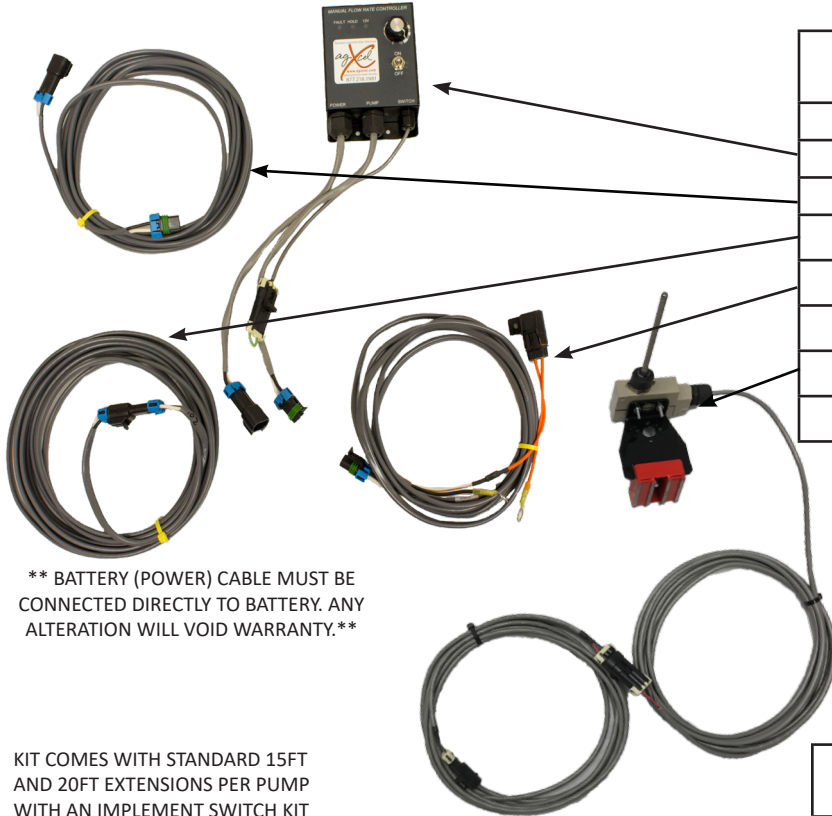

MANX CONTROL KIT SINGLE PN#563		
PN#	ITEM	QTY
17934	MANX CONTROLLER	1
18113	15 FT EXTENSION	1
53660	20 FT EXTENSION	1
17944	BATTERY CABLE 15FT **	1
ONLY 1 KIT BELOW WILL BE INCLUDED:		
53824*	RUN/HOLD KIT*	1
54066*	MERCURY SWITCH KIT*	1



\*KITS WILL COME WITH EITHER A MERCURY SWITCH OR AN IMPLEMENT SWITCH.

\*\* BATTERY (POWER) CABLE MUST BE CONNECTED DIRECTLY TO BATTERY. ANY ALTERATION WILL VOID WARRANTY.\*\*

KIT COMES WITH STANDARD 15FT AND 20FT EXTENSIONS PER PUMP WITH AN IMPLEMENT SWITCH KIT (OR MERCURY SWITCH KIT) WITH TWO 15FT EXTENSIONS AND MAGNET MOUNT. IN CASE OF A DUAL PUMP CONFIGURATION A "Y" HARNESS IS INCLUDED TO CONTROL BOTH PUMPS.

## FEATURES:

- Rheostat manual speed control for 12-volt pumps
- 6" wiring for power input and output for motor standard
- Sealed heavy-duty electrical connectors
- Reverse polarity protection
- On/Off control switch with power indicator lamp
- Smoother adjustment of pump flow/pressure, which results in reduced sensitivity at the top of the adjustment scale
- Optional stainless steel ammonia gauge can be mounted either outside of the cab or onto the control box with the provided bracket (PN# 53769)
- Run/Hold circuit on 35 amp units
- Control mounted hardware included
- All AgXcel Manual Rate Controllers are backed by a 1-year warranty

MANX CONTROL KIT DUAL PN#564		
PN#	ITEM	QTY
17934	MANX CONTROLLER	1
18113	15 FT EXTENSION	2
53660	20 FT EXTENSION	2
17944	BATTERY CABLE 15FT **	1
17945	"Y" PUMP CABLE	1
ONLY 1 KIT BELOW WILL BE INCLUDED:		
53824*	RUN/HOLD KIT*	1
54066*	MERCURY SWITCH KIT*	1



\*\* BATTERY (POWER) CABLE MUST BE CONNECTED DIRECTLY TO BATTERY. ANY ALTERATION WILL VOID WARRANTY.\*\*

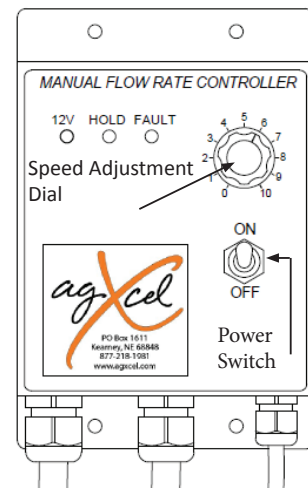

[www.agxcel.com](http://www.agxcel.com)

# MANUAL RATE CONTROL KIT

**SINGLE PUMP PN# 563**

**DUAL PUMP PN# 564**



**116 E 6TH ST  
KEARNEY NE 68847**

**877.218.1981**

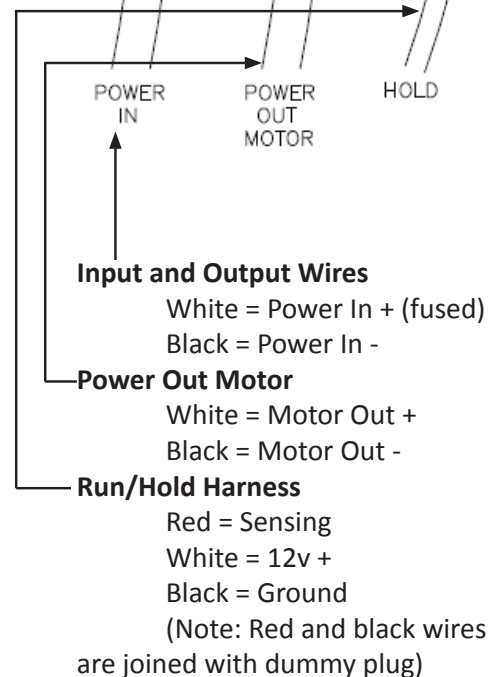
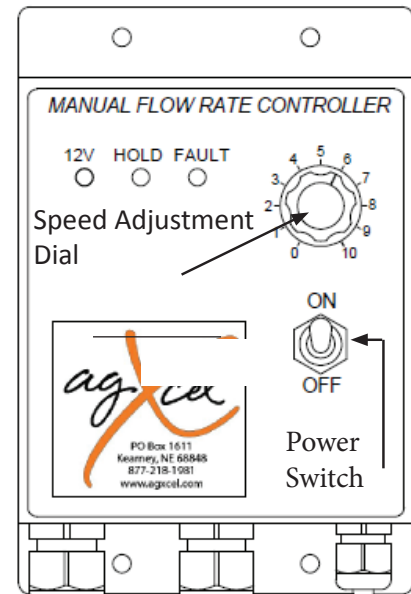
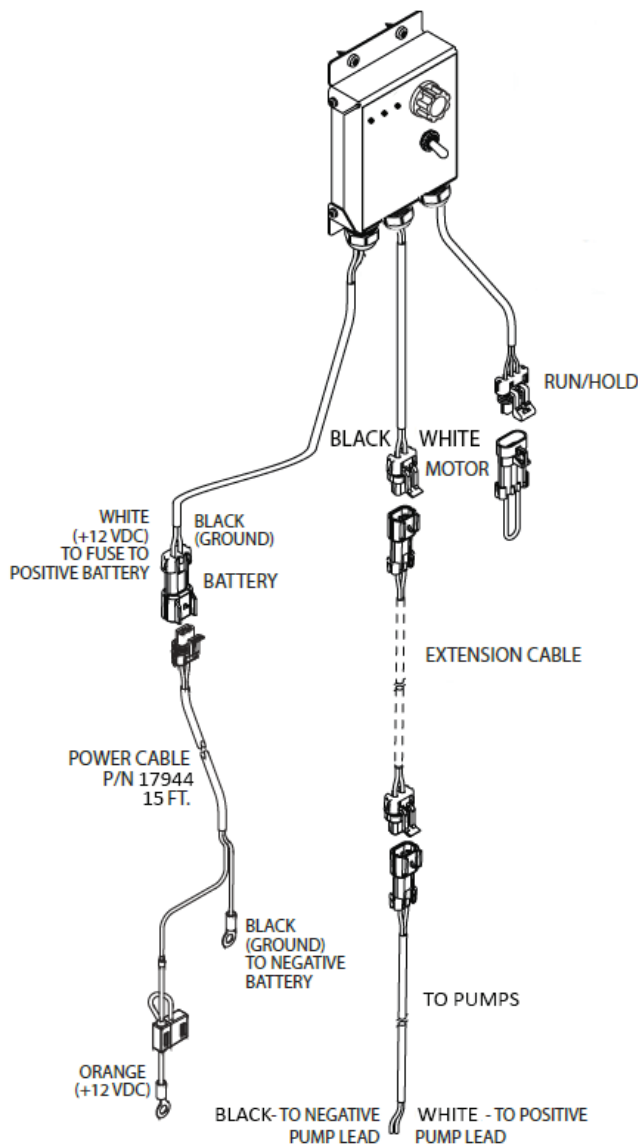

AVAILABLE EXTENSIONS	
PN#	ITEM
17939	5 FT EXTENSION
17958	10 FT EXTENSION
18113	15 FT EXTENSION
53660	20 FT EXTENSION
53661	30 FT EXTENSION
53662	40 FT EXTENSION
19630	50 FT EXTENSION
53663	60 FT EXTENSION



**\*\* BATTERY (POWER) CABLE MUST BE CONNECTED DIRECTLY TO BATTERY. ANY ALTERATION WILL VOID WARRANTY.\*\***



[www.agxcel.com](http://www.agxcel.com)

## MANUAL RATE CONTROL KIT

**SINGLE PUMP PN# 563**

**DUAL PUMP PN# 564**



**116 E 6TH ST  
KEARNEY NE 68847**

**877.218.1981**

## INSTALLATION AND OPERATION:

1. Verify that the motor/pump to be operated draws less than or equal to the control's rated capacity at full load. The control has an in-line fuse sized to the unit's capacity. Locate the control unit inside the tractor cab (out of the weather) and mount with the provided #10 screws.
2. **\*\* IMPORTANT \*\*** Only connect the harness with the WHITE and BLACK wires to the power source. The white wire is positive and the black is negative. Use a minimum of 12 AWG for the 35A control. If not connected directly to power source this will void warranty.
3. Connect the harness with the white and black wires to the motor. The white wire is positive and the black wire is negative. Use a minimum of 12 AWG for the 35A control. You must run both wires to the motor connections - do not run the black wire to ground.
4. **OPTIONAL EQUIPMENT:** Mount the pressure gauge (PN#53769) either outside of the cab or to the side of the controller using the supplied bracket. Connect the port of the gauge to an output line of the pump with the provided 1/4" poly tubing and 1/4" npt push-connect fittings. The tubing splice connector can be used as a line disconnect near the implement.
5. Run/Hold optional connection
  - For use with a N.O. (normally open) whisker switch, cut the looped wire in the dummy plug and connect to our switch wires. A smaller gauge wire (18 AWG minimum) may be used for this low current circuit.
  - For use with a hall-effect sensor, remove the dummy plug and attach the plug from your sensor.

## TROUBLESHOOTING:

### IF MOTOR WILL NOT RUN:

1. Check polarity of power connections (the control unit protected from reverse polarity).
2. Check for loose connections and a good ground.
3. Check for power (and proper voltage of 12-14 volts). Note that the unit will not run from a battery charger and that the LED should be illuminated if the power switch is set to "ON".
4. Check that the run/hold dummy plug is in place, or check that the tool bar switch is functioning correctly.

### IF MOTOR SPEED IS NOT BEING CONTROLLED (MOTOR IS ON BUT ONLY AT SINGLE SPEED)

5. Insure that BOTH of the motor wires (white and black) are attached to the motor leads DIRECTLY. Do not run the black wire to system ground.

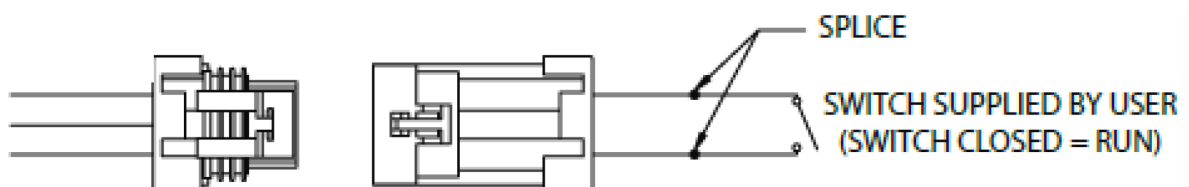

## **RUN/HOLD KIT (PN#53824):**

### **KIT INCLUDES:**

- 1- 15FT Extension (John Deere or 3pin connector)
- 1- Implement Switch with 15FT Lead (PN# 17921)
- 1- Magnet Mount (PN# 17960)



**116 E 6TH ST  
KEARNEY NE 68847**

**877.218.1981**

1. Run/Hold optional connection (If not using be sure to use provided loop to close circuit)
  - For use with a N.O. (normally open) whisker switch, cut the looped wire in the dummy plug and connect to your switch wires. A smaller gauge wire (18 AWG minimum) may be used for this low current circuit.
  - For use with a hall-effect sensor, remove the dummy plug and attach the plug from your sensor.

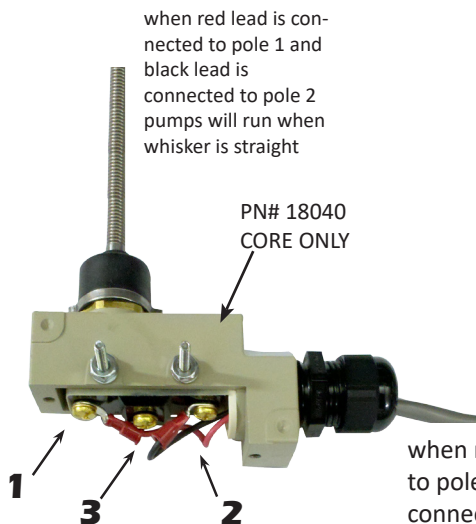

when red lead is connected to pole 1 and black lead is connected to pole 2 pumps will run when whisker is straight

### **HOW IT WORKS:**

Place the whisker switch on a 3 point arm or wheel frame that changes angle as the implement is raised and lowered. When the whisker arm is bent up (against the tool bar), the switch is open placing the MANX in HOLD, not applying fertilizer.

When the whisker arm is straight (not touching the toolbar), the switch will be closed. The MANX will be in RUN, applying fertilizer.

when red lead is connected to pole 1 and black lead is connected to pole 3 pumps will run when whisker is bent

\* The Whisker switch will work with many other controllers. However, the polarity might be reversed from the positions described above.

## **MERCURY SWITCH KIT (PN#54066):**

Run/Hold optional connection (If not using be sure to use provided loop to close circuit)

### **KIT INCLUDES:**

- 2- 15FT Extension(s) (John Deere or 3pin connector)
- 1- Mercury Switch (PN# 54024 - Switch only)
- 1- Magnet Mount (PN# 17960)

### **HOW TO ADJUST:**

If your controller is turning off product application before or after you want, tilt the switch. If it turns off after you want when lifting the implement, tip more to the HOLD position. If product application should begin sooner when you lower the implement, tip more to the RUN position.

### **HOW TO TEST:**

To test the run/hold mercury switch you will need a volt meter. Set the meter to test continuity (or ohms). With the wires down, you should have continuity between the two pins in the connector. With the wires up, the switch should be open (no continuity).

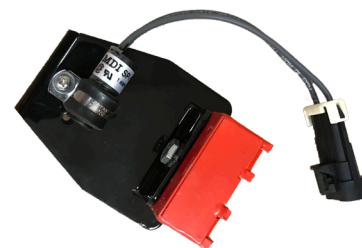

<b>EXTENSIONS AVAILABLE</b>	
3PIN	DESCRIPTION
17924	GXH_EXT 15FT
54073	GXH_EXT 30FT
*Custom extension lengths can be special ordered - contact SALES for a price quote*	

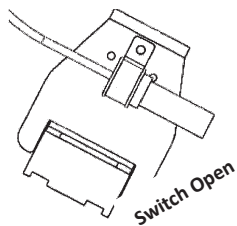

**HOLD** Position with Wires **UP**

### **MOUNT THE SWITCH ON:**

- 3 point arm if in use
- Planter wheel frame that changes angle
- Drill opener frame if openers are pivoted to raise out of ground.

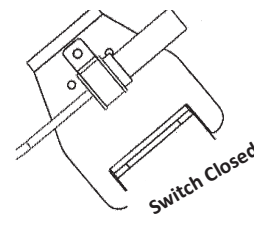

**RUN** Position with Wires **DOWN**

## **WARRANTY:**

AgXcel manufactured systems come with a 1 year limited warranty. Electronic components from our OEM vendors come with a 1 year limited warranty and some components only have a 90 day warranty. (e.g. the Garmin GPS devices)

AgXcel warrants that the products or services sold here shall be free from defects in material and workmanship under normal use and services when correctly installed, used, and maintained. This warranty of quality shall terminate 1 year after delivery of the product, and shall not apply to products which have been subject to misuse, abuse, neglect, improper storage, handling, or maintenance. If the product proves to be defective within the warranty period the purchaser must contact AgXcel technical support team to troubleshoot the product to verify the defect. If technical support feels there is an issue, at AgXcel's discretion a new or factory refurbished part will be shipped to replace the part in question. All product(s) replaced or repaired under warranty shall carry the remainder of the warranty left on the original purchase. Under no circumstances shall AgXcel be liable for special, indirect, or consequential damages. In particular AgXcel shall not be liable for damage to crops as the result of misuse or negligence in the application of chemicals or operation of AgXcel products.

Our warranty process is as follows:

- When a warranty claim is made; at AgXcel's discretion a new or factory refurbished part will be shipped and invoiced. It is very important to note that the invoice is due in full within 30 days from the invoice date. Finance charges will be applied if not paid in full. Credit to your account will be processed when OEM validates and approves your warranty claim.
- It is the Authorized Dealers'/Customers' responsibility to return the warranty part to AgXcel for review within 15 days. (Note return procedure below)
- Once the part is received AgXcel will test the part to justify the claim.
- Part is then shipped to the original manufacturer to validate for warranty.
- If the original manufacturer determines that the part qualifies; your account will be credited for the new part sent.
- If the manufacturer denies warranty and the part is in working order it will be returned to the authorized dealer.
- If the part is not in working order it will be discarded unless you request that it be returned to you.

## **RETURNS:**

AgXcel will gladly accept returns for new items purchased directly from us if returned within 30 days of receipt. However returned items must be accompanied by the original product packaging, any associated components and informational tags (such as flow meter calibration tag). Metal brackets are not returnable unless they are in new condition and are not scratched.

Authorized Dealers/Customers wishing to return items must contact AgXcel at 877-218-1981 or [info@agxcel.com](mailto:info@agxcel.com) prior to returning any items to request a RMA number. Packages sent with no RMA number are UNAUTHORIZED and will be REFUSED by our receiving department and returned to sender at sender's expense.

Once the return has been approved and a RMA number is obtained, AgXcel will contact the Authorized Dealer/Customer with RMA number and instructions on how to return the items.

Ensure that items are properly packaged; taking special care with items that can be scratched, damaged or broken during shipping. Clearly write the RMA number on the outside of the package and return to AgXcel. {Return shipping and handling fees are the customer's responsibility and will not be reimbursed by AgXcel.} AgXcel highly recommends that a traceable method of shipping is used for your protection. AgXcel is not responsible for damaged or lost items due to shipping.

Upon receipt of returned items AgXcel will inspect all the items and give the Authorized Dealer/Customer credit for the approved return within 30 days. Credit will not be given on items that are damaged, broken or used. This does not apply to warranty returns.

Credit for the RMA will be placed on the Authorized Dealers' account. To receive credit in the form of a check the Authorized Dealer must request this through AgXcel accounting. Customers' credit for the RMA will be issued when approved.

Returns will not be accepted for credit on items that are:

- Opened or used
- Special orders - Items that are specially ordered from an outside vendor not normally held in AgXcel stock
- Returned more than 30 days after delivery
- Returned without an RMA
- Returned in a package not well suited for the item
- Partial return of items originally sold as a kit

Products returned to AgXcel must be thoroughly cleaned and free of all chemical contamination. Items not properly cleaned will be returned to the owner at their expense.

A 20% re-stocking fee will be applied on all returned parts.

